

A revolutionary multi PDP
Infinitely expandable multi PDP

INFINITE
INFINITE

INFINITE
INFINITE



Address: 8F, Shindonghae Bldg., 15-3, Youido-Dong, Youngdungpo-Gu, Seoul, Korea
Tel : +82-2-6678-8522~8523, Fax: +82-2-6678-8599
Email: bgkim@orionplasma.co.kr, jwlee@orionplasma.co.kr
Homepage: www.orionplasma.co.kr

Infinitely expandable Multi PDP

M-PDP will change the way it shows.



The innovative M-PDP allows you to give a huger world and show up to unlimited size.

M-PDP is designed to provide larger display for advertising, monitoring and controlling. M-PDP is a super thin & digital multi-display developed by ORION PDP leading-edge digital technology. ORION PDP M-PDP is tailored to facilitate functionalities and make your business environment more efficient for a large place and digital era.

More than 4 planks are combined into a huge PDP display with thinnest seam. This is the representative character - infinitely expandable.

With M-PDP, you are no longer confined to a limited number of monitors.

No space is wasted for installment for its remarkable 10cm in thick.



Infinitely expandable Multi PDP

4 sides DZF technology implement seamless M-PDP

M-PDP come with an advanced ORION PDP technology-4 sides DZF (Dead Zone Free) technology making it possible not to have non-luminant area to the edge of each panel. It gives an excellence in continuity of displays with less than 4mm seam when consisting multi and improve the uniformity remarkably with 4-sides glass edge structure technology.

The newest developed edge structure allows for impressive reduction between screen. Picture can now appear as one complete image. Conventional PDP has its pad connected to circuit on the 3 or 4 sides of non-luminant area of front side of panel. Therefore they have more than 100mm seam between panels.

- See the comparison between M-PDP and conventional multi PDP.



네오다임 New Type Multi-PDP

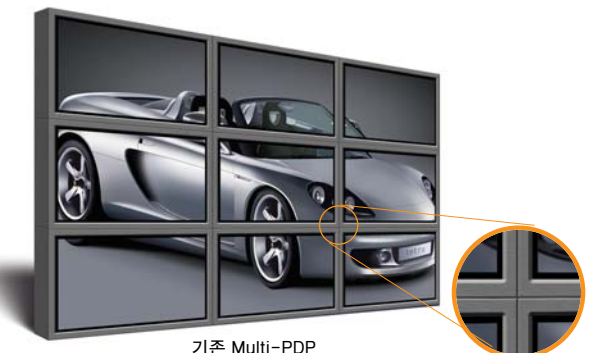

기존 Multi-PDP

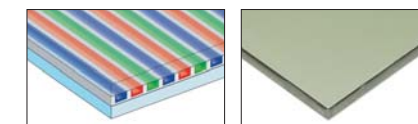

New Seamless Technology
PDP technology latest revolution

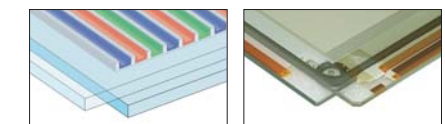

Conventional Multi PDP

Huge digital images spread before your eyes

M-PDP is the world standard multi-huge display in control room, advertising, conference room, lobbies, public transportations, event hall, surveillance, broadcasting, shopping mall and etc.

ORION PDP M-PDP is renowned for its flexible, market-specific approach, successfully implemented in over a thousand places world wide.

It provides wide viewing angles, flicker-free pictures, clear images and room-saving design.



네오다임 New Type Multi-PDP



Cube Type

오리온PDP의 최첨단 기술이 만들어낸 네오다임은 제품의 두께가 10cm에 불과하며, 다른 대형 디스플레이에 비해 무게가 가벼워 공간에 따라 다양한 연출이 가능하며 이동성이 매우 뛰어납니다.

VIDEO WALL TYPE



M-PDP is designed to provide larger display for advertising, monitoring and controlling. M-PDP is a super thin & digital multi-display developed by ORION PDP leading-edge digital technology. ORION PDP M-PDP is tailored to facilitate functionalities and make your business environment more efficient for a large place and digital era. More than 4 planks are combined into a huge PDP display with thinnest seam. This is the representative character - infinitely expandable.



Infinitely expandable Multi PDP

초대형화면, 초박형, 고화질 영상!!!

새로운 기술을 통해 기존의 멀티PDP와는 다른 자연스럽게 이어진 하나의 대화면을 제공, 각종 행사장 및 전시장, 제품발표회등 초대형 실감영상이 펼쳐집니다.



■ 4 X 4 type (168")



■ 3 X 3 type (126")



■ 2 X 2 type (84")

Video wall Application

■ 각종 행사장, 제품발표회, 전시회등



■ 방송국, 콘서트, 대강당, 세미나, 화상회의 등



■ 관제소, 빌딩통제소, 정보안내용, 상황실 등



SIGNAGE TYPE



Ininitely expandable Multi PDP

움직이는 영상으로 시선을 제압한다!!

슬림 디자인으로 공간 제약이 적어 어느곳이나 설치가능하며, 다양한 구성으로 효과적인 영상시스템을 구축할 수 있는 첨단 디지털영상 시스템입니다.



■ 1 X 1 type (42")

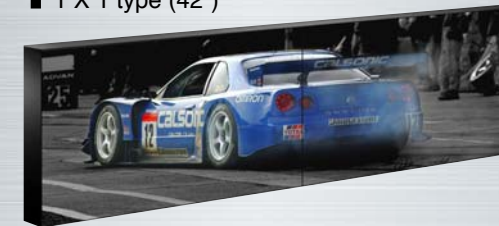

■ 1 X 2 type (75")



■ 1 X 4 type (147")

Signage Type Application

■ 은행, 자동차매장, 체인점 등



■ 대형매장, 기업홍보, 행사장입구 등



■ 박물관, 가제제품매장, 관공서 등



M-PDP is designed to provide larger display for advertising, monitoring and controlling. M-PDP is a super thin & digital multi-display developed by ORION PDP leading-edge digital technology. ORION PDP M-PDP is tailored to facilitate functionalities and make your business environment more efficient for a large place and digital era.
More than 4 planks are combined into a huge PDP display with thinnest seam. This is the representative character - infinitely expandable.

SPECIFICATION

PLANK TYPE

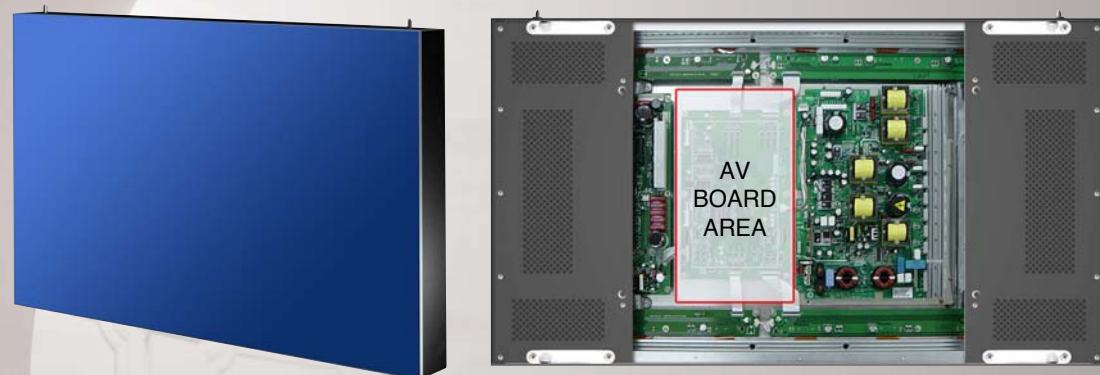

The World 1st 4-Sides Dead Zone Free Multi PDP

- Infinitely Extensible by n X n
- Invisible seam between screens
- Less power consumption
- More efficient display space
- Less maintenance labor
- Easy installation & AS
- Thin & fashionable design
- Much better image quality

Model	M-PDP
Screen Size	42"
Dimension	926 x 523 x 76.5 mm
Display Area	921 x 518 mm
Aspect Ratio	16 : 9
Number of Cells	853 x 480
Peak Brightness	1,000 cd/m ²
Contrast Ratio (dark Room)	3,000 : 1
Weight	25kg
Power Consumption	300w(max)
Seam폭(멀티 구성시)	5 mm
Video wall 구성	Multi screen (N X N)

PDP Plank : Module + Master Frame



Infinitely expandable Multi PDP

PDP Plank block diagram

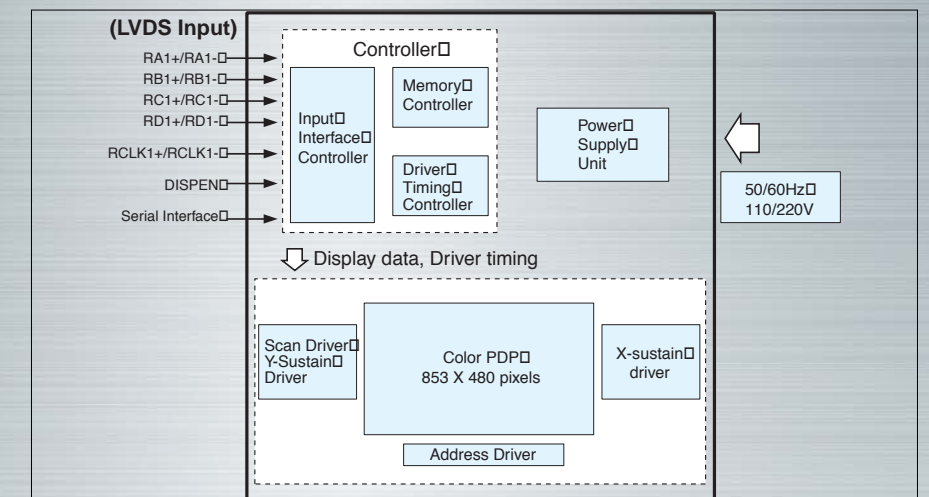

Innovative and the most competitive Solution for the Indoor Large Display Market

- Innovative commercial Display Device superior to Multi-Cubes and Single PDP
- High Performance Display Device with competitive price Superior Performance, but lower price than Multi-Cube system
- Overcoming the limitation of current Single PDP Tiling infinitely for various shape and size

M-PDP is designed to provide larger display for advertising, monitoring and controlling. M-PDP is a super thin & digital multi-display developed by ORION PDP leading-edge digital technology. ORION PDP M-PDP is tailored to facilitate functionalities and make your business environment more efficient for a large place and digital era. More than 4 planks are combined into a huge PDP display with thinnest seam. This is the representative character - infinitely expandable.

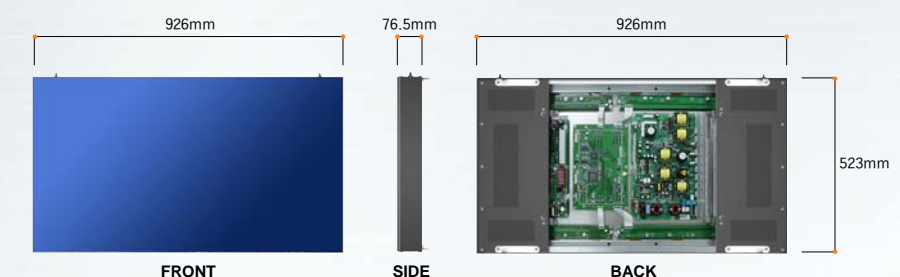

SPECIFICATION

IMAGE PROCESSOR TYPE



Image processor built-in

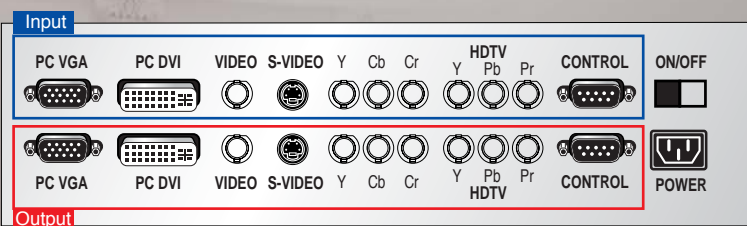
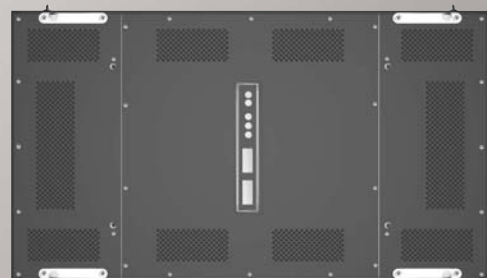
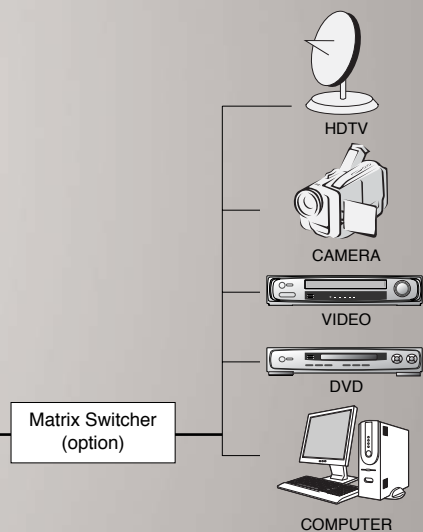

1. PC(RGB) GRAPHIC

- 75Ω, 0.7Vp-p, D-Sub 15-Pin, (up to WUXGA at 60Hz)

2. PC(DVI) GRAPHIC

- PC Digital Interface, DVI-D, (up to WUXGA at 60Hz)

3. Composite VIDEO

- 75Ω, 1Vp-p, BNC, (NTSC/PAL/SECAM)

4. S-VIDEO

- 75Ω, 1Vp-p, Mini-DIN, (NTSC/PAL/SECAM)

5. Composite VIDEO

- 75Ω, 1Vp-p, BNC, (NTSC/PAL/SECAM)

6. HDTV-Ready

- 75Ω, 1Vp-p, BNC, (up to FULL HD)

7. RS-232C (Loop-Back)

- 9P DIN Jack, RS-232C Control Output

8. Power

- AC 100/200 Volts (50/60Hz), Auto Selectable



Infinitely expandable Multi PDP

고선명 고화질 대화면의 MPDP 방식

- 고품질의 디지털 회로 설계
- 전용 Digital Processor 채택
- Image Interpolation
- No Frame Skip(Tear)
- PC(RGB) 전용 입/출력 단자
- 비디오 전용 입/출력 단자
- R/S-232C 통신 Port 지원
- 전용 소프트웨어에 의한 편리한 제어 기능

RS-232C control function

- Power (on/off)
- Input select(Video, RGB, S-Video, DVI/ PC)
- Zoom(up/down)
- Auto adjust, ID Select, Clear
- Picture
 - Contrast / brightness / sharpness / color / tint / color temperature / white balance / picture mode / noise reduction / Gamma / Low tone / Color tune
- Image adjust
 - V-position / H-position / V-height / H-width, / Fine picture, / Picture adjustment / Auto Picture (on/off), aspect mode

Other Function

- Motion compensated 3D Scan converter (NTSC, PAL, 480i, 576i, 525i, 625i, 720p, 1080i)
- 2-3 pull down converter (film Mode) (NTSC, 480i, 525i, 1080i)
- 2-2 pull down converter (film Mode) (PAL, 576i, 626i, NTSC, 480i, 525i)
- 3-D deinterlacing
- Scaling (Nonlinear or linear)
- Digital zoom Function : (100~900% selectable)
- Self diagnosis / Image burn reduction tool : Orbiter (Auto 1,2 / Manual), Screen wiper, White, Inverse, PLE LOCK 1~3)
- Color temperature select : high / mid / mid low / low
- Control lock
- Auto picture
- Low tone
- Auto ID
- Programmable timer
- Gamma correction (4 mode)

* Input & output terminals are added in case of monitor.
 * The specifications and design are subject to without notice.
 * Product color may vary due to printing procedure